



Jet Stream (SAP*) Car Seat

Groups 1+2+3 child car seat

*side armour protection



This product conforms to ECE R44.04

Group 1+2+3 child car seat. Suitable for children from 9kg to 36kg (approx 9 months to 12 years old)

Instructions: Please read carefully and keep for future reference. Your child's safety may be affected if you do not follow these instructions.

Notices

1. The child car seat must only be used in vehicles which are fitted with a three point seatbelt system that has been approved by regulation ECE-16 or similar.
2. A correct fit is likely if the vehicle manufacturer has declared in the vehicle hand book that the vehicle is capable of accepting a 'Universal' child restraint for this group.
3. The child car seat is a 'Universal' child restraint; it conforms to regulation ECE-R44/04 for general use in vehicles. It will fit most, but not all vehicle seats.
4. This child car seat has been declared 'Universal' under more stringent conditions than those applied to earlier designs, which do not carry the 'Universal' mark.
5. Child car seats can mark vehicle seat upholstery. The manufacturer cannot be held responsible for damage or marking to vehicle seats.
6. The following situations could be illegal and will invalidate the warranty: 1) Any modifications or change of use of the child car seat that have not been authorised or advised by the manufacturer. 2) Any failure to fit the child car seat in strict accordance with the instructions.
The manufacturer accepts no liability for issues arising from unauthorised modifications, uses or fitting.
7. Please keep this manual safe for any possible queries you may have in the future.
8. You will need to keep your proof of purchase. We recommend you keep them together.

GETTING STARTED

Read Carefully Before Attempting to Fit the Child Car Seat

- Warning:** NEVER leave your child unattended – your child's safety is your responsibility.
- Warning:** The child car seat must be fitted in accordance with the manufacturer's instructions. Incorrect installation could be dangerous.
- Warning:** This installation must only be performed by a competent adult. Don't try to install the seat when intoxicated or drowsy.
- Warning:** Always ensure that new or occasional users [e.g. grandparents] have read the instructions or been taught the correct installation by someone who has read and understood the instructions.
- Warning:** Always keep this instruction manual with the child car seat, or in the vehicle in which you are carrying the child car seat. Some models of child car seat have a pocket to store the instructions.

Before Starting

- Warning:** Do not fit the child car seat on a side or rear facing vehicle seat.
- Warning:** Before installing the child car seat ensure that the passenger seat you are using is locked in the upright position.
- Warning:** Do not use the child car seat in the home - it has only been designed to be used in the car.
- Warning:** Do not leave loose/unsecured objects on the back seat of your car or the parcel shelf. They may be dangerous to your child if you are forced to brake suddenly.

Which is the safest passenger seat to fit your child car seat to?

THE CENTRE REAR PASSENGER SEAT

- If your centre rear passenger seat is fitted with a three point seatbelt system then you should use it.
- If your centre rear passenger seat does not have a three point seatbelt system (i.e. no seatbelt at all, or only a lap belt):
- then you should use the rear left passenger seat or the rear right passenger seat.
- The front passenger seat can only be used if it **DOES NOT** have an airbag and **IS** fitted with a three point seatbelt system.

EXTREME HAZARD

**NEVER USE IN FRONT PASSENGER SEATS EQUIPPED WITH AIRBAGS (SRS)
THIS CAN INCLUDE REAR PASSENGER SEATS THAT ARE EQUIPPED WITH AIRBAGS***

***Consult car manufacturer for suitability. Children's bodies are not able to withstand the forces exerted on them by a deploying air-bag**

When Using the Child Car Seat

Warning: Make sure that the child car seat is placed somewhere so that rigid items and plastic parts do not become trapped in doors or movable seat units when the seat is in everyday use.

Warning: Always use the vehicle's door child safety lock system, if one is available, to make it impossible for the child to open the car doors from inside.

Warning: Allow the child a break during long car journeys and make sure they don't get out of the car unaided and without supervision.

Warning: The child car seat must be fitted securely to the passenger seat. Ensure that it is not loose or wobbly after you have fitted it. If it is loose, re-fit it.

Warning: Ensure that the child car seat is secured to the car seat at all times - even when not in use.

Warning: The child car seat must not be used without its original cover. The original cover is essential for the safe operation of the child car seat.

Warning: Stop the car at regular intervals to check that the child car seat is in the correct position and that both the car seatbelt **AND** the child car seat harness (if fitted) are still taut and latched.

Warning: If you travel with passengers using both the front and the rear passenger seats, the lighter occupants should be in the rear and the heavier occupants in the front.

Warning: If you have no option other than to put your child car seat on a rear passenger seat next to side airbags:

- Consult with your vehicle manufacturer for side airbag details. It may not be safe.

- Make sure your child does not lean into the area immediately around the airbag.

Warning: Do not place anything under the child car seat (e.g. a towel or cushion) as this could affect the performance of the seat in an accident.

Warning: Avoid winter clothing bundling - Bulky clothing can lead to incorrect harness tightening. In an accident, the child can slip right out of the extra padding - and thus out of the seat. Let the car warm up or cool down prior to placing your child in there if possible. If your child is cold, place a blanket over the top of the harness.

Warning: In the event of an emergency it is important to be able to release the child quickly (as defined by British Standards). This means that the seat buckle cannot be fully tamper proof and you should actively discourage your child from playing with or using the buckle.

Important: Ensure your child knows the harness is there to keep them safe.
Important: Do not start the engine until you are sure that your child is securely harnessed in their seat **AND** that you have also correctly fastened your seatbelt. Ask your child if everyone is safely belted up and whether it is okay to drive off.

For tips and advice on preventing your child from tampering with the harness buckle visit one of the following sites:

- http://www.theaa.com/motoring_advice/child_safety/belts_buckles.html
- <http://www.childcarseats.org.uk/choosing-using/children-undoing-their-harness/>

Seatbelt

Warning: NEVER use any load bearing contact points other than those described in these instructions or marked on the child car seat.

Warning: Ensure that the lap section of the seatbelt or harness is worn low down, so that the pelvis is firmly engaged.

Warning: Make sure that **ALL** the passengers in your vehicle have their seatbelts fastened, as unrestrained people can be very dangerous to the child in an accident.

Warning: NEVER use a seatbelt routing scheme that differs from these instructions.

Warning: The lap and diagonal seatbelt (and harness if fitted) must be used at all times when your child is in the child car seat.

Warning: Make sure that there are no twists in the seatbelt.

Sunlight/Hot days

Warning: Do not leave your child in the child car seat while parked in direct sunlight or on a hot day.

Warning: Do not subject the child car seat to prolonged direct sunlight as this may be dangerous for your child (the metal and plastic fittings could become hot) and may cause the fabric to fade. You can reduce this problem by covering the child car seat with a sheet when not in use.

Back of the Seat/Headrest

Warning: Ensure that the child car seat is as close as possible to the backrest of the car seat.

Warning: REMOVE the head rest of the passenger seat being used if it obstructs the proper installation of the child car seat. **REMEMBER** to refit the headrest when the child car seat has been removed.

Second Hand or Damaged Child Car Seats and Seatbelts

Warning: Never buy a second hand child car seat. It may have unseen damage.

Warning: The manufacturer only guarantees this product when the original owner uses it.

Warning: You **MUST** replace the child car seat and your vehicles seatbelts if they becomes badly worn or damaged.

Warning: You **MUST** replace the child car seat if it is involved in an accident – it may have unseen damage and may not protect your child as well as they should. At the very least send the child car seat to the manufacturers for inspection, together with the accident report.

Your 3 year warranty

Whilst we make and test our products to the highest standards of durability there's always a small chance of a hiccup! Our promise is to repair, replace or refund a MyChild product that has an identified manufacturing defect from the date of purchase for a full 3 years thereafter at no extra cost.

However, you must register within 28 days of the date of purchase to receive the full 3 years guarantee!

To receive your full guarantee you can register your product by: visiting www.mychildonline.co.uk/warranty.html and complete the warranty form, or by telephone on 0161 335 2508.

Contents

General safety information - READ FIRST	1-4
Welcome	5
Parts checklist	6
Positioning the seat	7
Four-position seat recline	7
Installing for group I [9-18kg]	8-9
Adjusting the headrest and harness height	10
Placing your child in the seat - group I [9-18kg]	10-11
Converting for groups II [15-25kg] + III [22-36kg]	12-15
Installing for groups II [15-25kg] + III [22-36kg]	15-16
Removing the seat cover	16-17
Replacing the seat cover	17-18
Replacing the harness	18-21
Maintenance and cleaning	21

Welcome

Thank you for purchasing the Jet Stream (SAP) child car seat. Please read these instructions carefully before use to ensure safe and satisfactory operation of this product.

Your child's safety is your responsibility. If you have a query with this product or require replacement parts, please contact your nearest MyChild retailer.

Parts checklist

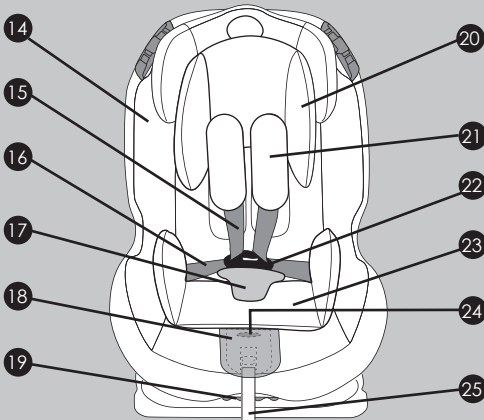
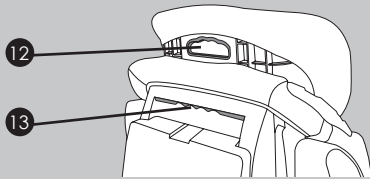
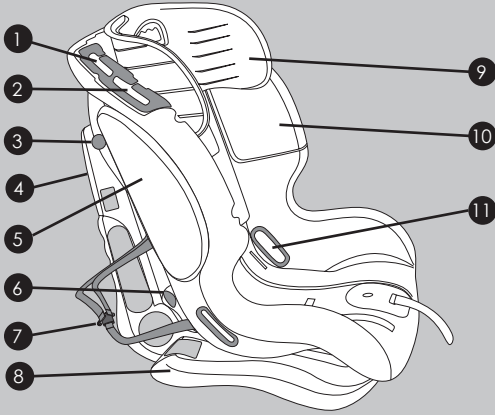

- 1 Group II Belt guide slot
- 2 Group III Belt guide slot
- 3 Installation bar
- 4 Rear shell
- 5 Side Armour Protection (SAP)
- 6 Lap belt hook
- 7 Belt yoke
- 8 Base
- 9 Headrest
- 10 Front shell
- 11 Belt guide hole
- 12 Headrest and harness height adjuster handle
- 13 Carry handle
- 14 Seat cover
- 15 Shoulder strap
- 16 Waist strap
- 17 Buckle pad & crotch strap
- 18 Adjuster button cover
- 19 Recline adjuster handle
- 20 Head cushion
- 21 Harness shoulder pads
- 22 Central buckle
- 23 Booster cushion insert
- 24 Harness adjuster button
- 25 Harness adjuster strap

Positioning the seat

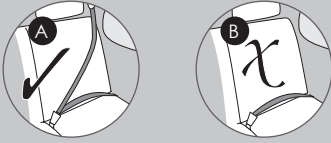

The child car seat can only be used with an automatic 3-point safety belt (A) and **NOT** with a 2-point lap belt (B).

The child car seat can be secured in a forward-facing position in the rear seats of the vehicle by using the existing seatbelts. However, on some seats, if the installation is not properly secured, we suggest you try another seat in your vehicle.

Although not recommended, the child car seat can be used on a passenger side front seat, so long as there is no active airbag in place.

WARNING: Never use in a seat with an active airbag.

Four-position seat recline

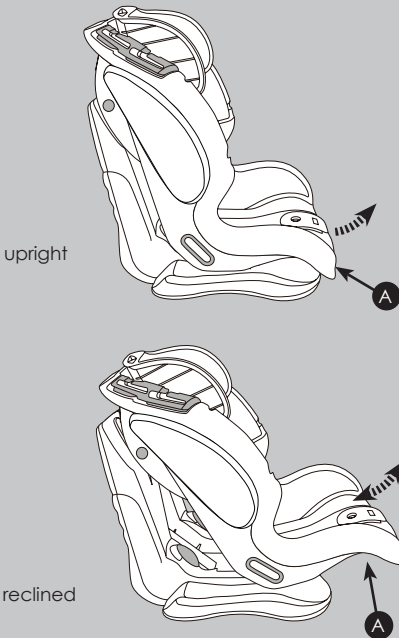

The child car seat can be used in four different seat positions, from seated to a reclined sleeping position. Pull the recline adjuster handle (A) under the front of the shell and pull the shell forwards or backwards, release the handle on your required position when hearing a distinct click.

Installing for Group I [9-18kg]

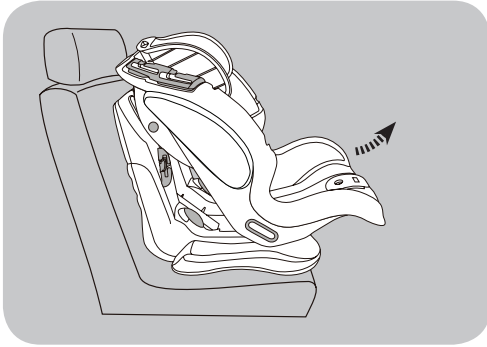

Place the child car seat on a suitable passenger seat. Pull the recline adjuster handle under the front of the shell and adjust the shell to its fully reclined position.

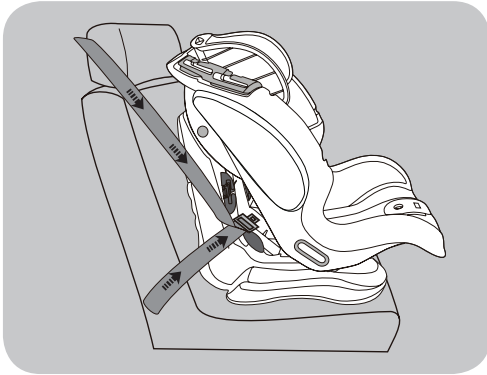

Feed the seatbelt between the shell and the base and ensure the seatbelt is not twisted.

Push the child car seat back into the passenger seat ensuring a good fit.

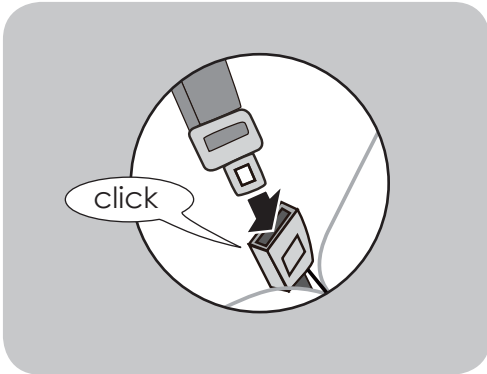

Plug the seatbelt into the vehicles buckle until you hear a "click".

Installing for Group I [9-18kg] (continued)

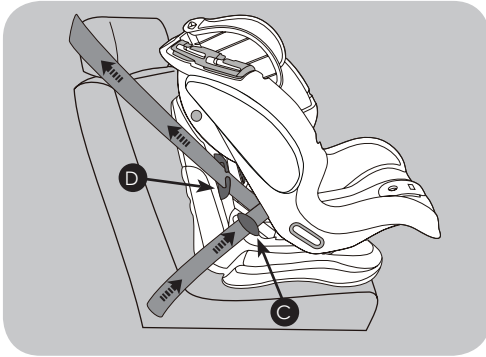

Thread the horizontal lap belt section under both hooks (C) and remove all the slack by pulling up on the diagonal section of seatbelt. Thread the diagonal section through the lock off device (D).

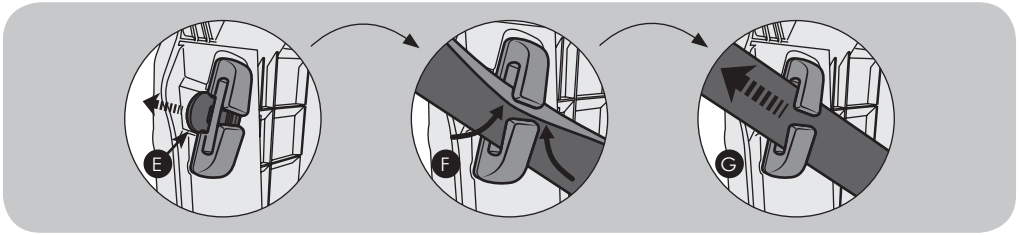

To operate the lock-off device:

Pull down on tab (E) to open the locking device.

Feed the seatbelt into the gap between the tab and the locking device (F).

Pull the diagonal section of seatbelt tight (G).

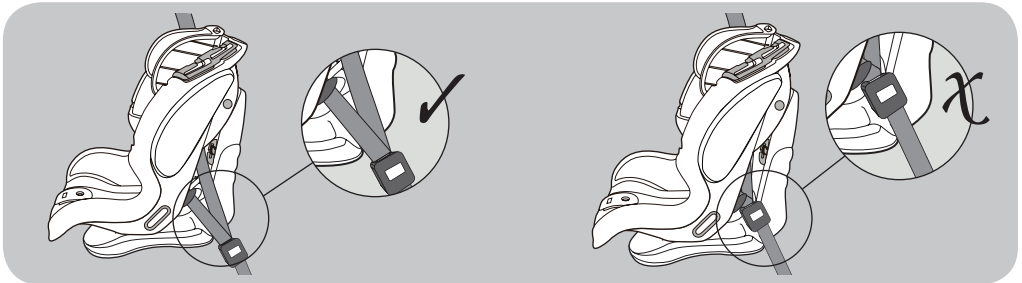

With your child car seat now buckled in, check it is secure by pulling forward from both harness straps, there should be little or no movement. Next check that the vehicle's seatbelt buckle is **NOT** resting against the child car seat shell. This is called 'buckle crunch' and could cause the child car seat to work loose or the seatbelt to come undone in an accident. If you find you are experiencing 'buckle crunch' then this child car seat is not suitable for your vehicle.

WARNING: The child car seat should always be strapped in using the vehicle's seatbelt, whether a child is seated in the child car seat or not.

Adjusting the headrest and harness height

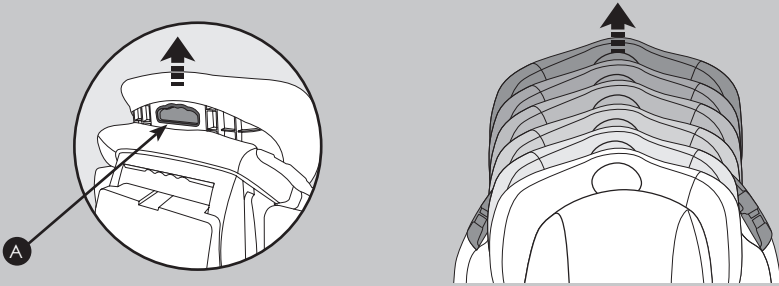

Adjust the headrest by pulling the adjuster handle (A) on the back of the headrest and raising or lowering according to your child's height.



The harness strap slots should be level with your child's shoulders.

Placing your child in the seat - Group I [9-18kg]

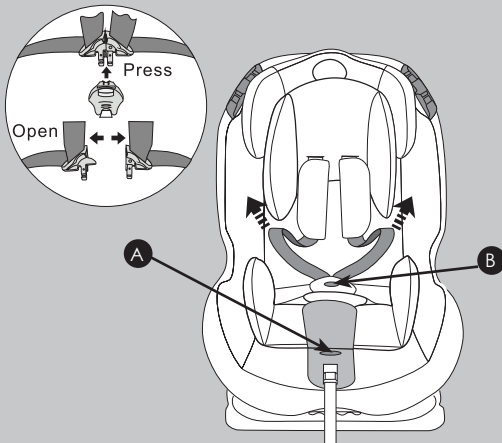

Ensure that you have first installed the child car seat correctly, following the steps under 'Installing for Group I [9-18kg]',

Press button (A) and pull forward on the shoulder straps (not the shoulder pads) to loosen the straps.

Press the red 'buckle release' button (B) and unbuckle the harness.

IMPORTANT: DO NOT pull the shoulder pads or the straps above the shoulder pads.

Placing your child in the seat - Group I [9-18kg] (continued)

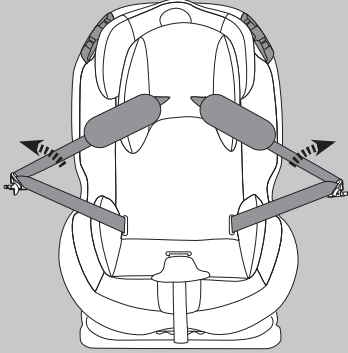

Place the harness straps over the side of the shell, position your child in the child car seat ensuring no toys or other hard objects are in the seat.

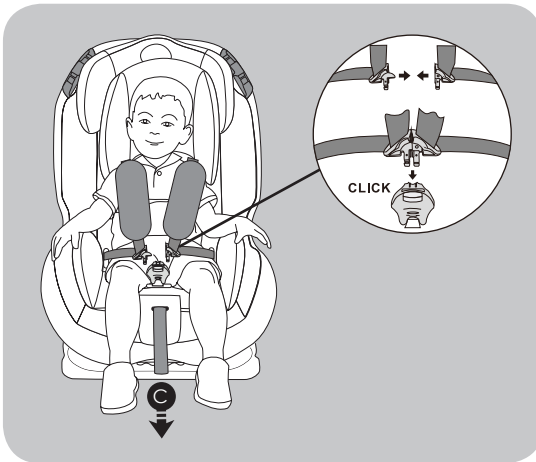

After placing your child in the child car seat, match the two halves of the harness buckles together and insert them into the crotch buckle. Make sure the shoulder straps fit your child snugly by pulling the adjuster belt (C).

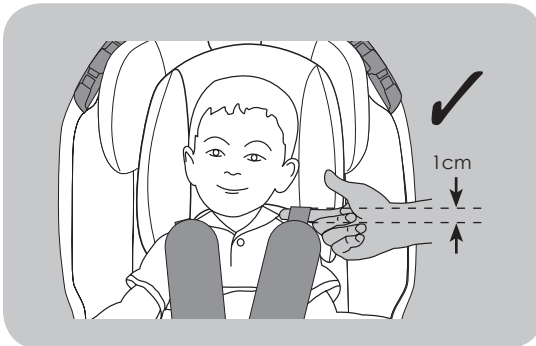

The harness should allow 1 finger-width (1cm) of space at the top of the shoulders. This is the ideal tightness.

Note: check that the buckle is secured by tugging the shoulder and waist straps.

Converting for groups II+III [15-36kg]

It is recommended that you use the 5-point harness for as long as possible. Try removing the booster cushion as this could allow you to use the seat in group I configuration for longer.

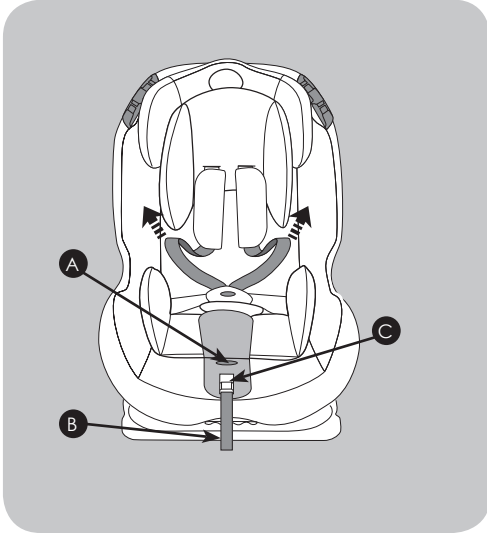

When your child has outgrown the group I (9-18kg) configuration and you wish to use the seat for a child in either group II (15 - 25kg) or group III (22-36kg) then you will need to remove the child car seat's integral 5-point harness.

Lift the fabric adjuster cover at the front of the car seat and whilst pressing button (A), pull forwards on the shoulder straps (not the shoulder pads) to completely loosen the harness straps and shorten the adjuster strap (B) as much as possible. Any remaining strap can be rolled up and stored under the red plastic cover (C).

IMPORTANT: DO NOT pull the shoulder pads.

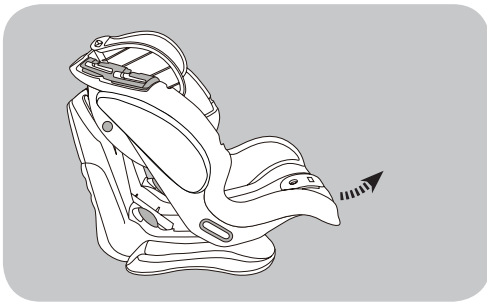

Pull the recline adjuster handle under the front of the shell and whilst holding it, pull the shell forwards to its most reclined position.

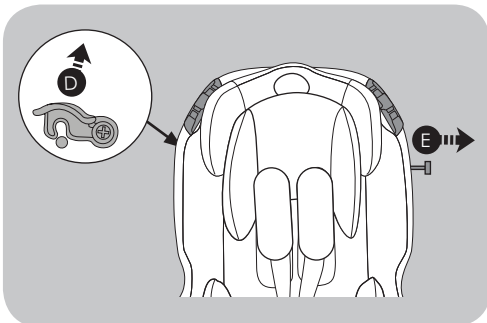

Release catch (D) on the top left hand side of the shell and remove the installation bar (E).

Converting for groups II+III [15-36kg] (continued)

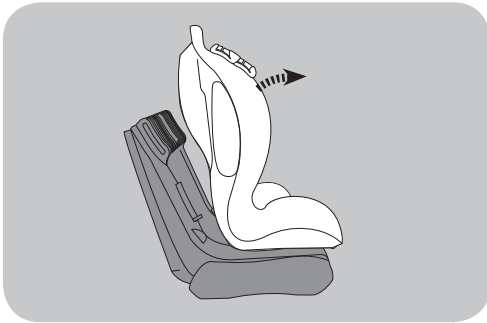

Pull and hold the shell forward.

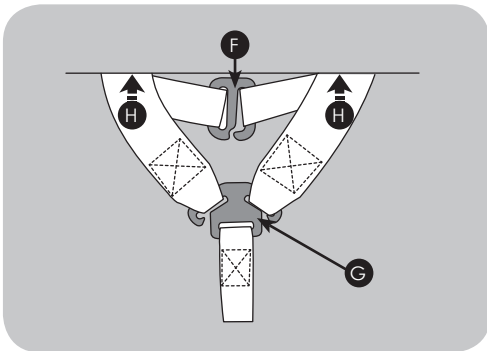

Unhook the shoulder pad straps from shoulder pad connector (F). Unhook the shoulder harness straps from yoke (G).

Pass the shoulder straps through the slots in the back of the shell (H).

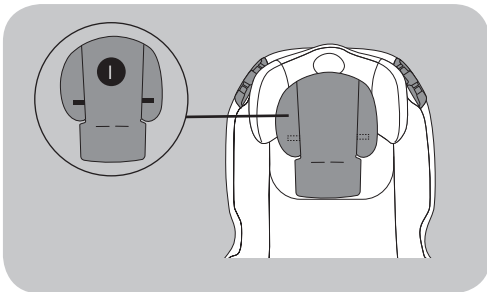

Undo the two Velcro® tabs on each side of the back of the head hugger (I) and remove.

Converting for groups II+III [15-36kg] (continued)

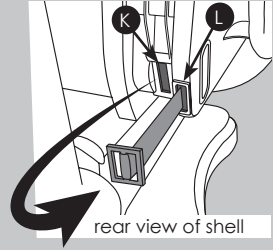
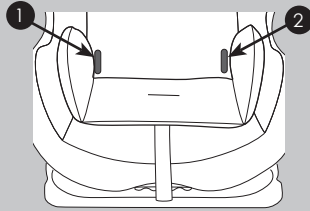
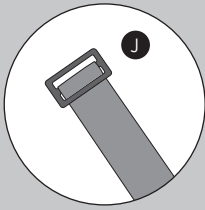

Locate the two metal retainer buckles (J) under the seat cover at points (1) and (2). Pass the metal buckles on the waist harness from the front of the shell, through the inner slots (K) on the back of the shell and back out the outer slots (L), to the front to remove the harness.

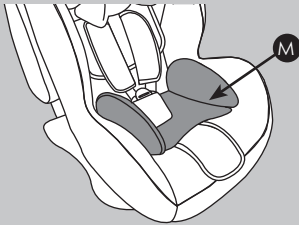

Remove the booster cushion insert (M) from the crotch strap.

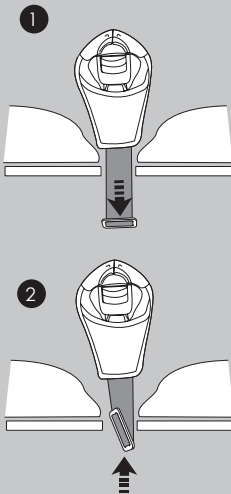

To remove the crotch strap, ensure the child car seat is in a fully reclined position.

1. Push the crotch strap down through the slot.

2. Whilst holding the strap locate the metal retainer buckle underneath the car seat shell, turn the retainer buckle and post through the letter box opening and remove the crotch strap.

Converting for groups II+III [15-36kg] (continued)

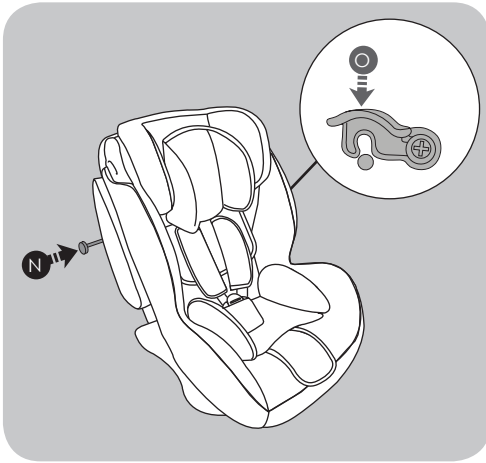

Return the shell to its original position and re-insert the installation bar (N) and secure the catch (O).

The child car seat can now be placed into your vehicle.

WARNING: The child car seat should always be strapped in using the vehicle's seatbelt, whether a child is seated in the child car seat or not.

Installing for groups II [15-25kg] + III [22-36kg]



Ensure that you have first removed the child car seat's integral 5-point harness, following the steps under 'Converting to group II+III [15-36kg]' pages 12-15,

You can use the booster cushion insert if your child needs it.

Position your child in the child car seat, adjust the headrest by pulling the headrest and harness height adjustment handle on the back of the headrest and raise or lower according to your child's height.

Installing for groups II [15-25kg] + III [22-36kg] (continued)

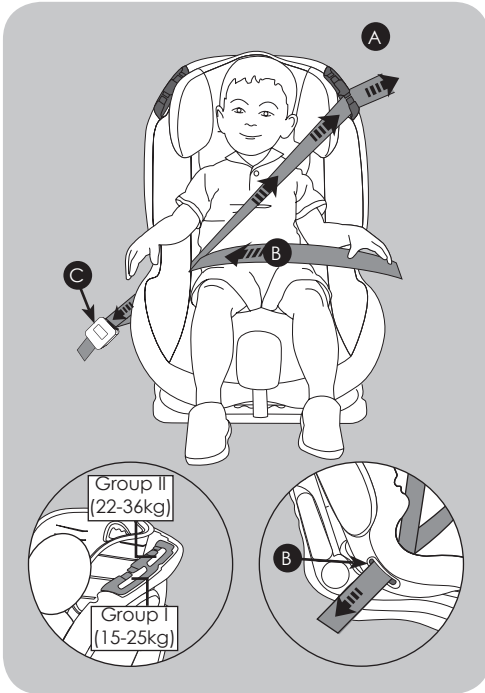

Place the seatbelt shoulder strap through the most suitable belt guide slot (A): Use the lower strap hook for children in group I [15 - 25kg].

Use the higher strap hook for children in group II [22 - 36kg].

Place the lap belt over your child's lap and thread through the belt guide hole (B) on the side nearest the seatbelt buckle (C). Fasten the seatbelt buckle (C) and remove all slack from both the lap and diagonal sections of seatbelt.

WARNING: The child car seat should always be strapped in using the vehicle's seatbelt, whether a child is seated in the child car seat or not.

Removing the seat cover



WARNING: The cover is a safety feature. Never use the child car seat without it.

Remove the harness straps, crotch strap, head pad and seat pad (see 'Converting to group II+III [15-36kg]' pages 12-15.

Remove the headrest cover (A) by grasping the elastically band and pulling the cover off.

Removing the seat cover (continued)

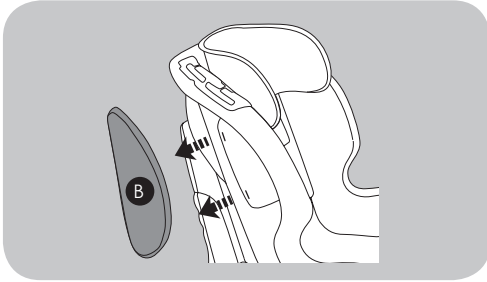

Pull the two (SAP) Side Armour Protection systems (B) in the direction of the arrows to unclip them from the shell and remove their covers.

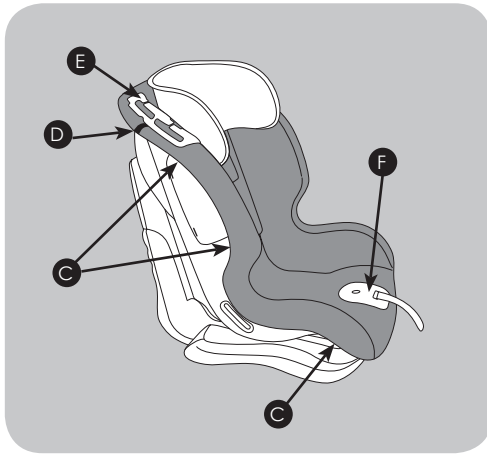

The main cover is held in place by a series of hooks (C) located on the back and underside of the shell. Unhook the cover's elastic from the hooks. Undo the Velcro® tabs (D) on the shoulders of the shell, work the cover from under the strap hooks (E) and from around the plastic adjuster panel (F) and remove the cover.

Replacing the seat cover

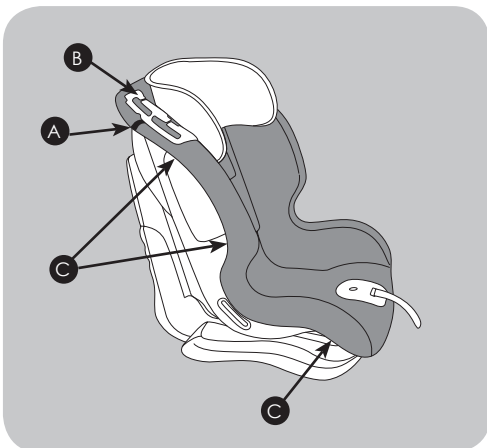

WARNING: The cover is a safety feature. Never use the child car seat without it.

Place the main seat cover over the child car seat and stretch the elasticated band around the shell, taking care as you work the cover over and around the plastic parts. Ensure the Velcro® tabs (A) pass under the strap hooks (B).

Once in place secure the cover on the hooks (C) located on the back and underside of the shell.

Replacing the seat cover (continued)

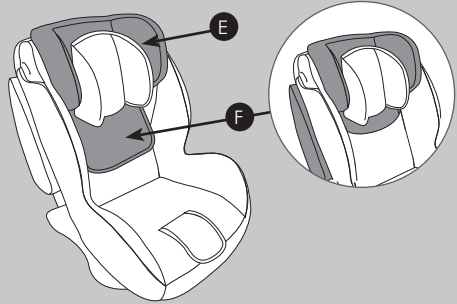
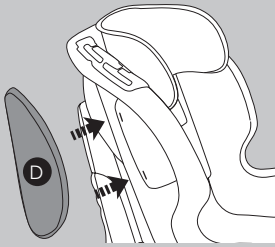

Stretch the side covers over the two (SAP) Side Armour Protection systems (D) and clip them back on to the shell. Once clipped on jiggle them to ensure they are firmly clipped on.

Stretch the headrest cover (E) over the headrest and tuck the lower part of the headrest cover (F) behind the main seat cover.

Replacing the harness

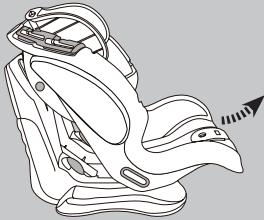

Adjust the shell to its most reclined position.

Pull the recline adjuster handle under the front of the shell and whilst holding it, pull the shell forwards to its most reclined position.

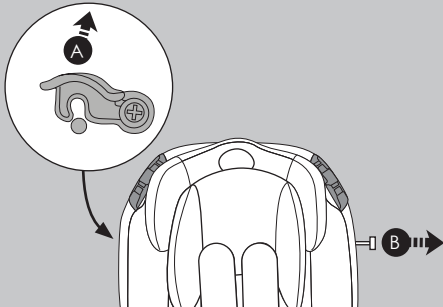

Release catch (A) on the top left hand side of the shell and remove the installation bar (B).

Replacing the harness (continued)

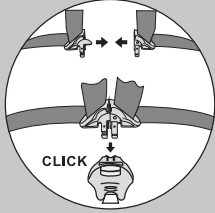

Take the two harness shoulder straps with the buckle clips and crotch strap and match the buckle tongue sections together and insert into the buckle.

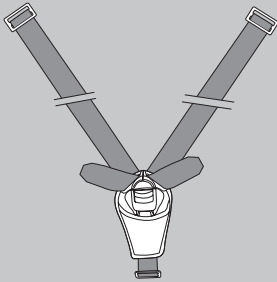

With the buckle connected you will have something similar to the illustration opposite.

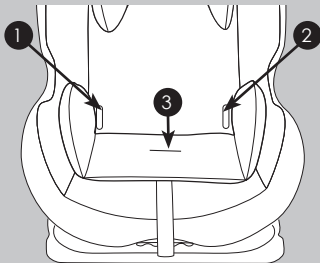

Insert waist strap retainer buckles (C) through the two slots (1) and (2) on the cover and out through the outer slots on the back of the shell then back through the inner slots. Insert crotch strap retainer buckle (D) through slot (3).

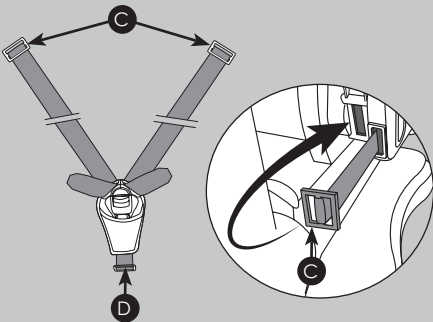

Replacing the harness (continued)

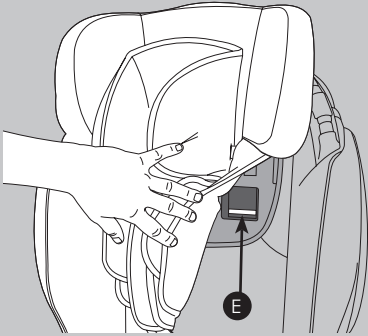

Adjust the headrest so that when you lift up the headrest fabric you are able to see the metal bar (E) through the backrest. Slide the shoulder pads (F) over the shoulder harness straps (G), ensuring the seams of the shoulder pads are facing outwards.

Push the shoulder pad and harness straps through slots (1 & 2) on the head hugger (H) (if fitted) and the headrest fabric. Lift up the fabric and take the straps through the shell over the metal bar (I).

ATTENTION: The shoulder pad and harness straps MUST pass over the metal bar, failure to do so will result in an incorrect installation.

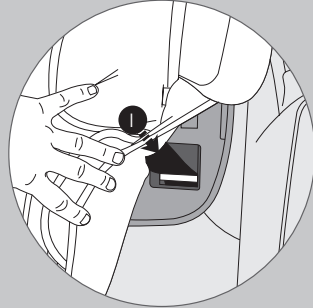
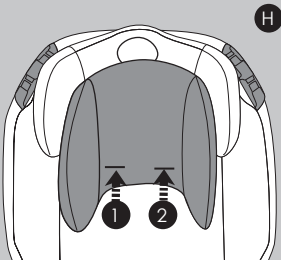
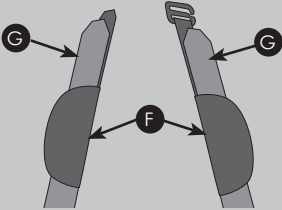

Connect the narrow shoulder pad straps to the shoulder pad connector (J). Connect the wider shoulder harness straps to the yoke (K).

ATTENTION: Check that the harness straps are correctly attached to the yoke and ensure the straps are not twisted.

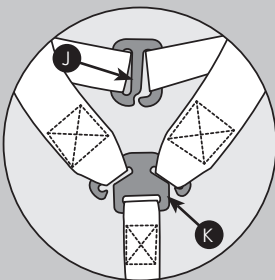

Replacing the harness (continued)

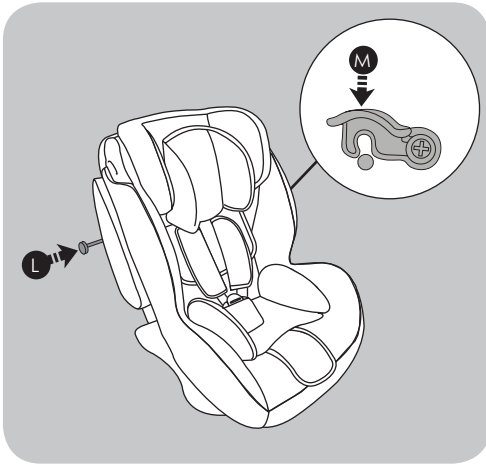

Return the shell to its original position and re-insert the installation bar (L) and secure lock (M).

Maintenance and cleaning

Storage

- 1) Store this child car seat in a safe place when not in use.
- 2) **DO NOT** place heavy objects on top of it.
- 3) Always store the child car seat in a dry environment.
- 4) **DO NOT** store the child car seat near a direct heat source such as a radiator.

Covers

- 1) The seat cover is easily removable and should be handwashed with a pH neutral soap and cold water.
- 2) Do not press, iron, dry clean, tumble dry or wring the covers.
- 3) Do not use solvents, caustic or abrasive cleaning materials.
- 4) Dry flat, away from direct heat and sunlight.
- 5) If the seat covers need to be replaced only use MyChild certified parts. They are the only ones that are guaranteed to have been safety tested and designed to fit this seat.

Plastic/Metal Parts

- 1) Wipe clean using a mild soap and warm water.
- 2) You must not remove, dismantle or alter any part of the seat shell.
- 3) You must not oil or lubricate any part of the seat shell.

Inspection

- 1) Check your child car seat regularly for wear and tear.
- 2) The child car seat may have a slight rattle when not in use, this is normal. If in any doubt, contact MyChild immediately.
- 3) Check the adjustable parts of your child seat at intervals of about 6 months to ensure it is still fits correctly for your growing child.



Customerservice@kooltrade.co.uk
Imported by MyChild. M34 3QA
www.mychildonline.co.uk
Tel: 0161 335 2508