

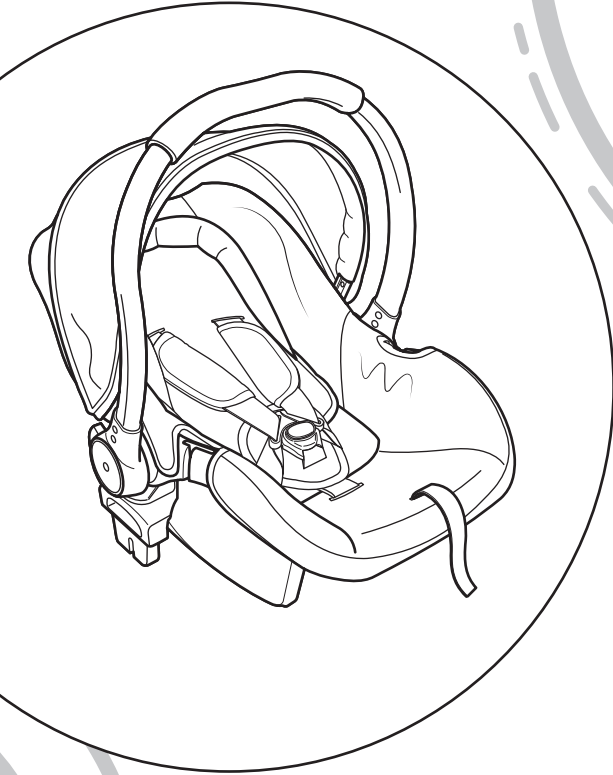

Floe Infant Carrier

For the Floe Convertible Pushchair



INSTRUCTIONS: PLEASE READ CAREFULLY AND KEEP FOR FUTURE REFERENCE. YOUR CHILD'S SAFETY MAY BE AFFECTED IF YOU DO NOT FOLLOW THESE INSTRUCTIONS.

This product conforms to ECE R44.04
This product is tested to BS EN 1888:2012

Group 0+ child car seat.
Suitable for children from birth to 13kg (approx. 12 months)

Safety advice

WARNING: The correct fitting of the vehicle seatbelt (following the guide markings) is of vital importance for the safety of your child. See the labels on the seat itself.

WARNING: Keep these instructions with the child car seat for future reference.

WARNING: Never leave your child unattended.

WARNING: NEVER use the child car seat on a passenger seat that is fitted with a front airbag. **THIS CAN BE VERY DANGEROUS.**

- The product is only safe if it is used in strict accordance with these instructions.
- The product must be replaced if it is involved in an accident as it may have unseen damage.
- Do not use this product second hand as you do not know its history.
- Ensure that all other passengers, luggage and loose objects are properly secured.
- Do not lubricate any of the moving parts.
- It is recommended that the child car seat should not be used more than 5 years from the date of production as the product may deteriorate due to, for example, ageing of the plastic.
- Never use the child car seat without the covers. Only covers approved by the manufacturer may be used.
- The child car seat must be secured with the vehicle seatbelt when not in use.
- Ensure that the child car seat is not damaged by heavy objects or being caught in the car door.
- Never make unauthorised alterations to the product.
- Child car seat parts may become hot in direct sunlight. Cover with sheet to prevent this.
- Most accidents occur on short trips, so do not be tempted to avoid using the child car seat simply because you are not travelling very far.
- Do not leave the child in the child car seat for long periods of time. Take regular breaks on long journeys.
- Set a good example by always wearing a seatbelt yourself.
- Make sure that your child never plays with the buckle.

WARNING: Failure to follow each of the following instructions can result in your child striking the vehicle's interior during a sudden stop or crash.

WARNING: Take care that the straps holding the child car seat to the vehicle, are as tight as possible. Make sure that the straps restraining the child are adjusted to the child's body and the straps are not twisted.

WARNING: The child restraint system **MUST BE CHANGED** after it has suffered from a violent impact in an accident.



! Extreme Danger !

Do not use a rear facing child car seat on a front passenger seat where an active passenger air bag is fitted. The air bag inflates rapidly and can throw a rear-facing child car seat into the back of a passenger seat with great force, which can injure or kill a child.

Vehicle seatbelt

The product must only be used with a 3-point vehicle seatbelt that has been approved to ECE R16 or equivalent. **NEVER** use a 2-point seatbelt. Your child car seat can be fitted in most cars. However, some cars are designed so that proper installation is not possible. In this case, try another seat.

Vehicle seat travelling advice

In order to maximise the protection that the child car seat can give your child, please adjust the harness so that it fits snugly and make sure that the child car seat is fitted correctly.

Research shows that correct installation is the most important factor in child car seat safety. Please take the time to read the instruction manual carefully.

Our product offers maximum protection when it is used in accordance with the instructions.

If you have any questions concerning the use of the product please do not hesitate to contact us.

- This child car seat is designed for use for children whose weight is 13kg or less and whose heights are 66cm (26 inches) or less.
- This child car seat must only be used in a rear facing position, and must **NEVER** be used forward facing. For maximum protection, the centre rear seat position (if it is fitted with an adult 3-point seatbelt) is recommended as the safest position in most vehicles for installing an child car seat. (Only use the vehicle's rear centre seat if the vehicle seat is fitted with a 3-point adult belt).
- Do not use your child car seat on a vehicle seat with lap belts only.
- Your child car seat should not be purchased or sold as a second hand item.
- Remove child out of the car as first priority in an accident.
- While travelling it is recommended that any luggage or other objects liable to cause injuries in the event of a collision shall be properly secured.
- Your child car seat should be securely belted to the vehicle, even when unoccupied because in a crash an unsecured child car seat may injure other passengers.
- Please take a rest every two hours if you are travelling with a baby in the child car seat.
- Please check the child car seat condition if you are going to travel a long distance with a child.
- Please put all excess luggage into the boot of your car if you are going to travel with a baby, because loose items may hurt a baby when travelling on unstable roads or because they move suddenly when braking.
- Please always check the child car seat before you place a baby into it.
- Please get in touch with the dealer if anything breaks on the child car seat. Only the manufacturer or an authorised agent may do repairs. **DO NOT** try and fix the child car seat by yourself. It might be damaged or cause more damage.
- Always check the buckle hole before you buckle up as it may contain crumbs or obstructions that prevent a secure lock.
- Keep your child car seat out of reach of children when not in use.
- Please keep the plastic packaging bag out of the reach of children when unpacking the child car seat.
- **NEVER** place the child car seat on a seat where an air bag is active.
- Do not modify the child car seat.

Notices

1. The child car seat must only be used in vehicles which are fitted with a three point seatbelt system that has been approved by regulation ECE-16 or similar.
2. A correct fit is likely if the vehicle manufacturer has declared in the vehicle hand book that the vehicle is capable of accepting a 'Universal' child restraint for this group.
3. The child car seat is a 'Universal' child restraint; it conforms to regulation ECE-R44/04 for general use in vehicles. It will fit most, but not all vehicle seats.
4. This child car seat has been declared 'Universal' under more stringent conditions than those applied to earlier designs, which do not carry the 'Universal' mark.
5. Child car seats can mark vehicle seat upholstery. The manufacturer cannot be held responsible for damage or marking to vehicle seats.
6. Never use rearward facing child car seat on a passenger seat with an active airbag.
7. If in doubt, consult manufacturer or the retailer.

Safety advice for Floe Chassis & car seat

WARNING: To avoid injury ensure that your child is kept away when unfolding and folding this product.

WARNING: Do not let your child play with this product.

WARNING: Never leave your child unattended.

WARNING: Ensure that all the locking devices are engaged before use.

WARNING: Always use the restraint system. Always use the crotch strap in combination with the waist belt.

WARNING: Parcels, accessories and other items (e.g. hand bags, shopping bags, etc) that are placed on the handles, back of the backrest or sides of the pushchair will affect the stability of the pushchair.

WARNING: Always use the most reclined position for new born babies.

WARNING: Do not lift and carry the pushchair with a child in it.

WARNING: Do not use pushchair on steep slopes, stairs, escalators, beaches, mud, etc.

WARNING: Check that the pushchair body or seat unit attachment devices are correctly engaged before use.

WARNING: Do not allow your child to climb unassisted into or out of the pushchair.

WARNING: Ensure that children are clear of moving parts before making adjustments.

WARNING: Never leave raincovers, hoods and aprons on indoors or in hot weather as your child might overheat.

WARNING: Do not use replacement parts or accessories other than those approved by the manufacturer as others may render the product unsafe.

WARNING: Do not load the basket with a weight in excess of 2kg.

WARNING: Always apply the brakes when the pushchair is stationary, and when placing and removing children.

WARNING: Taking children up or down stairs, escalators, steps, steep slopes and muddy/rough terrain could be dangerous and should not be attempted. Remove your child from the pushchair for easy carrying to negotiate such hazards, or simply avoid them.

WARNING: Never assume a driver can see you or your child.

WARNING: If your pushchair is to be used by someone who is unfamiliar with it, e.g. grandparents, then show them how it works before letting them use it.

WARNING: This pushchair is not suitable for running or skating.

WARNING: Hold onto your pushchair when close to moving vehicles and trains as the draught from the vehicles may move the pushchair even with the brakes on.

WARNING: This product is designed to carry only one child at a time.

This product complies with BS EN 1888:2012

Welcome

Thank you for purchasing the Floe 0+ Car Seat.

Please read the instructions and warnings carefully before use to ensure safe and satisfactory operation of this product.

Your child's safety is your responsibility. If you have a query with this product or require replacement parts, please contact your nearest MyChild retailer.

Parts checklist

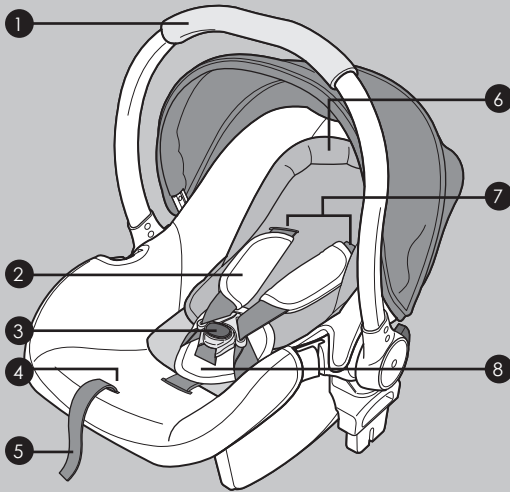

- 1 Carry handle
- 2 Shoulder pads
- 3 Harness buckle
- 4 Harness adjuster button (under seat cover)
- 5 Harness adjuster strap
- 6 Insert cushion
- 7 Shoulder strap slots
- 8 Crotch pad

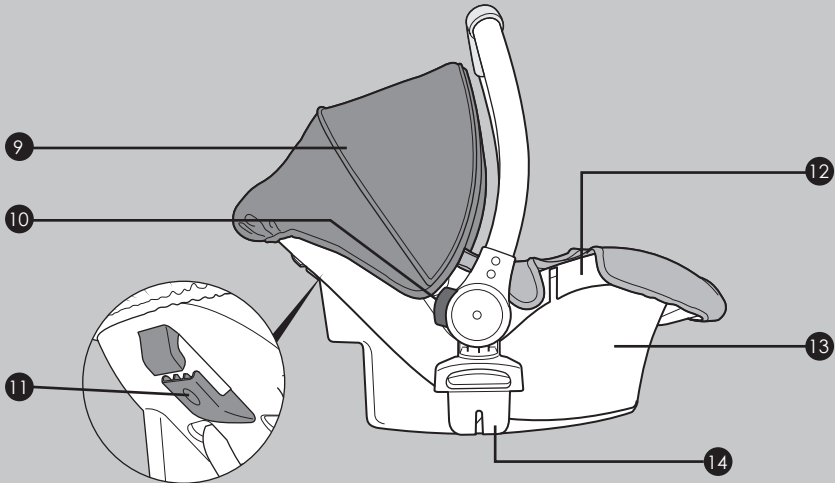

- 9 Hood
- 10 Handle adjuster buttons (on left and right of shell)
- 11 Diagonal seatbelt guide (on rear of shell)
- 12 Lap belt guides
- 13 Shell
- 14 Pushchair adaptors

Positioning the child car seat

The child car seat can only be used with an automatic 3-point safety belt (A) and **NOT** with a 2-point lap belt (B).

The child car seat can be secured on forward-facing back seats of the vehicle by using the existing seat belts. However, on some seats, if the installation is not properly secured, we suggest you try another seat in your vehicle.

Although not recommended, the child car seat can be used on a passenger side front seat, so long as there is no active airbag in place.

WARNING: Never use on a seat with an active airbag.

WARNING: Never use on rearward or side facing vehicle seats

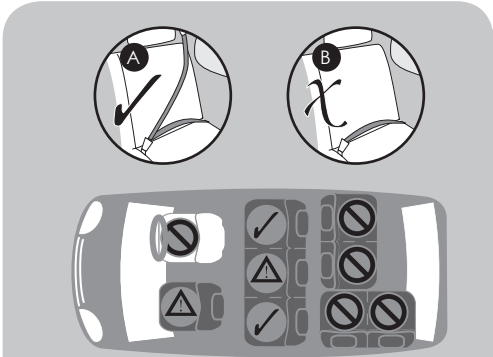

Front passenger seat (no active airbag)	Yes
Front passenger seat (active airbag)	NO
2-point seatbelt	NO
3-point seatbelt	Yes
Back left & right seats	Yes
Back centre seat (3-point seatbelt)	Yes
Back centre seat (2-point seatbelt)	NO
Side facing seats	NO
Rear facing seats	NO

The child car seat must not touch the front passenger seat.

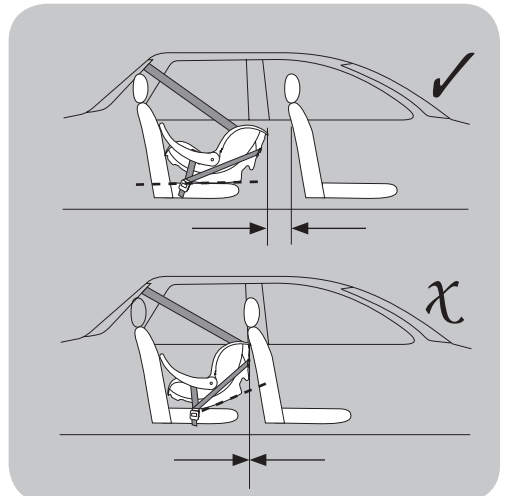

Adjusting the carry handle

The carry handle has 4 positions.

- (1) Feeding/non-rocking position.
- (2) Rocking position.
- (3) Carrying position: Make sure handle is locked before lifting.
- (4) Fitting position.

Press both buttons (A) and rotate the handle to the desired position.

WARNING: NEVER place the child car seat on a soft surface e.g. cushion, mattress, pillow etc, due to risk of suffocation if child car seat tips over. Never leave a child unattended.

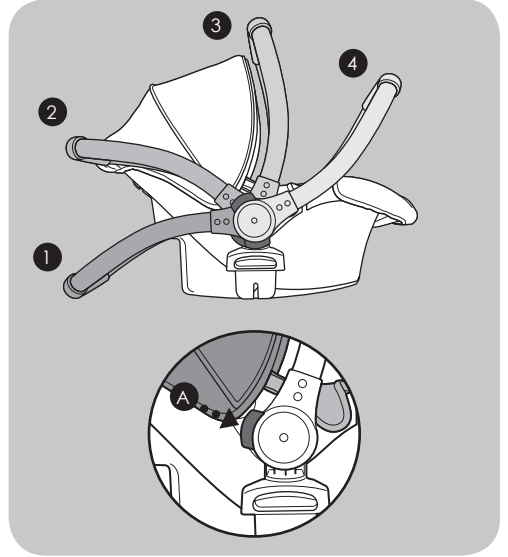

Adjusting the shoulder harness height

The harness should exit the child car seat at the same height as the child's shoulder and should not exit higher or lower than the child's shoulder.

WARNING: You should not attempt to adjust the harness height with a child seated in the child car seat.

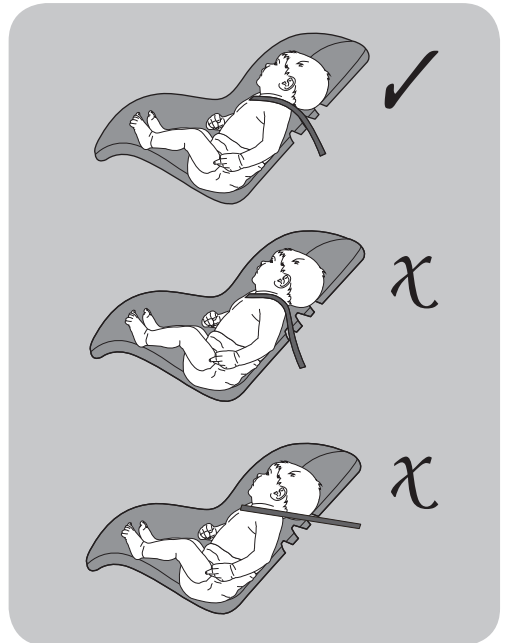

Adjusting the shoulder harness height (continued)

Press the belt adjuster button and pull on the shoulder harness straps to create slack.

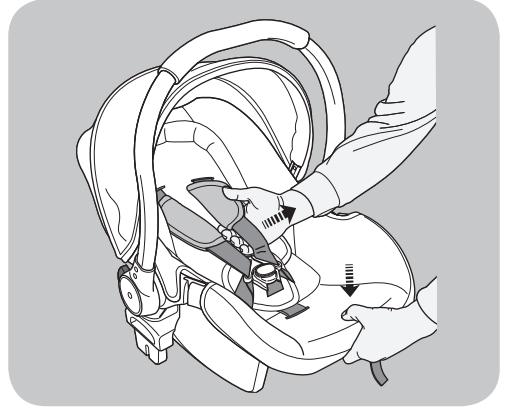

Press the red release button (A), unbuckle the harness, move the shoulder straps apart and remove the shoulder pads.

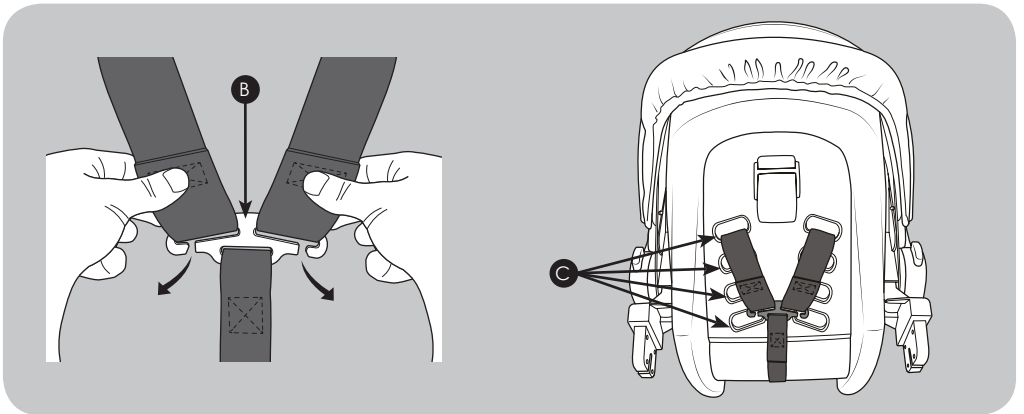
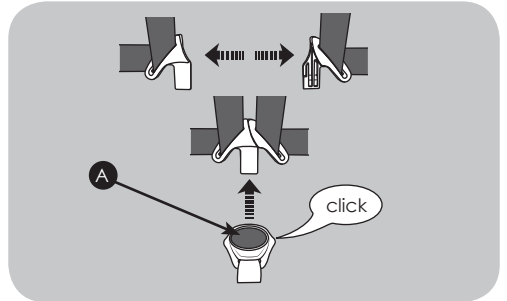

Unhook the shoulder straps at the rear of the seat shell by sliding the straps through the slits in yoke (B). Remove the straps, pulling them out from the front of the seat.

Pass the shoulder straps back through at one of the four desired heights (C) and reconnect them to the yoke (B).

Adjusting the shoulder harness height (continued)

Buckle up the harness. Connect the two shoulder strap connectors (D) and insert into the buckle (E). Ensure harness buckle is firmly clicked into place.

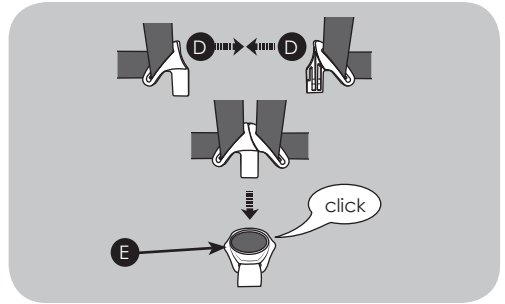

Pull the harness adjuster strap tight and check straps are not twisted.



Adjusting the crotch strap

The crotch strap can be repositioned for a more comfortable fit as your child grows. To reposition the crotch strap: pass the strap retainer up through one of the 3 slots in the base of the child car seat and thread it back down through the desired slot.

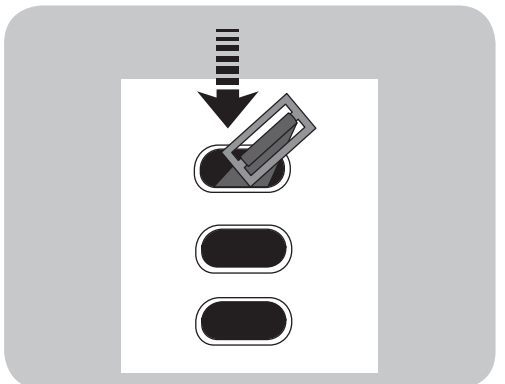

Fitting the harness

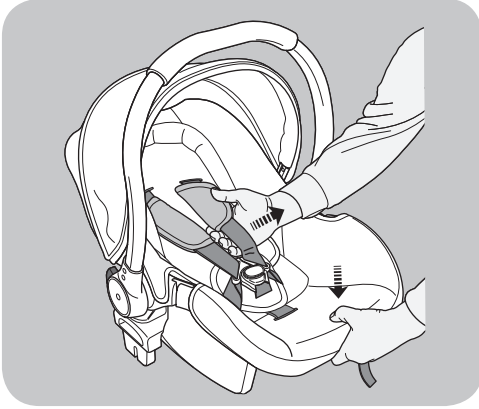

Press the belt adjuster button and pull on the shoulder harness straps to create slack.

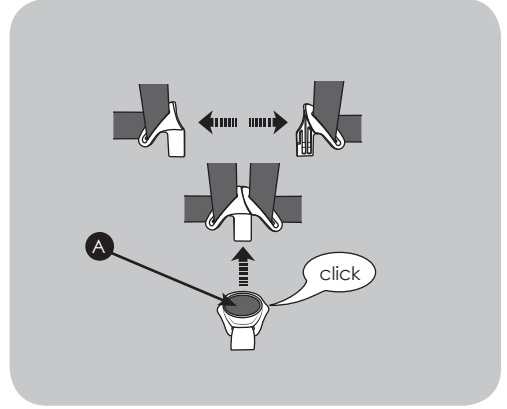

Press the red release button (A), unbuckle the harness and move the shoulder straps apart.

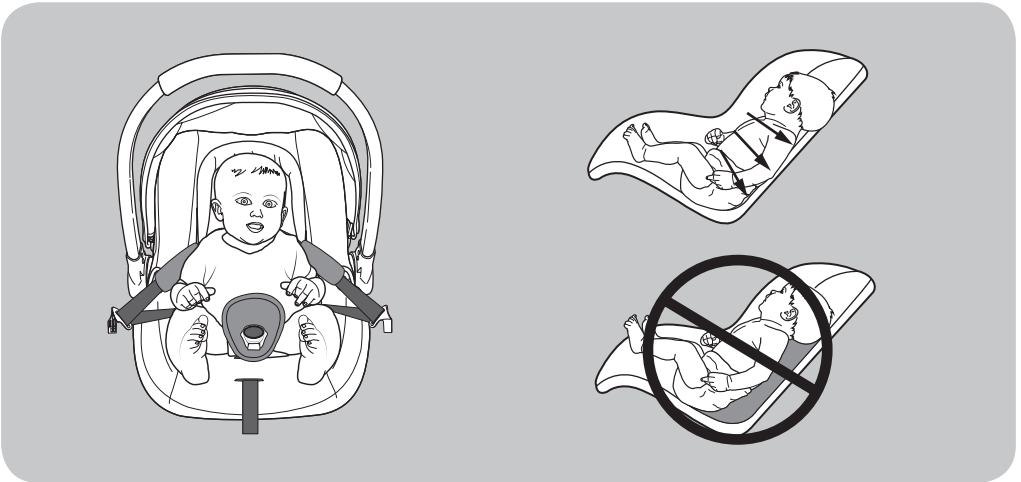

Place the child in the child car seat and ensure there are no spaces under the child.

Note: a new born baby may need extra support around the head and body. Ensure you use the supplied insert cushion if you are going to use it for a newborn or small baby less than 7 months old (9kg or less). Also ensure that the shoulder harness is at the lowest height setting.

Fitting the harness (continued)

Place the shoulder harness over the shoulders.

Note: Do not place your child in a sleeping bag, blanket or other bulky wrapping before putting the child in the child car seat. The shoulder straps will not fit snugly and the child will not be safe.



Buckle up the harness. Connect the two shoulder strap connectors (B) and insert into the buckle (C). Ensure harness buckle is firmly clicked into place.

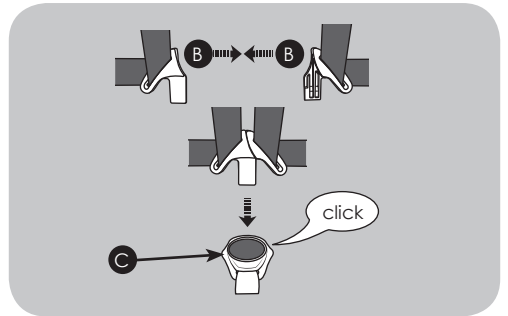

Pull the harness adjuster strap to secure the harness around the child.



Fitting the harness (continued)

The harness should allow 1 finger-width (1 cm) of space at the top of the shoulders. This is the ideal tightness.

Note: Check that the buckle is secured by tugging the shoulder and waist straps.



Fitting the child seat in a vehicle

Choose a seat suitable for fitting the child car seat to. See page 6, 'Positioning the child car seat'.

Place the child car seat rearward-facing on the vehicle seat. Ensure the handle is in the fitting position as shown.

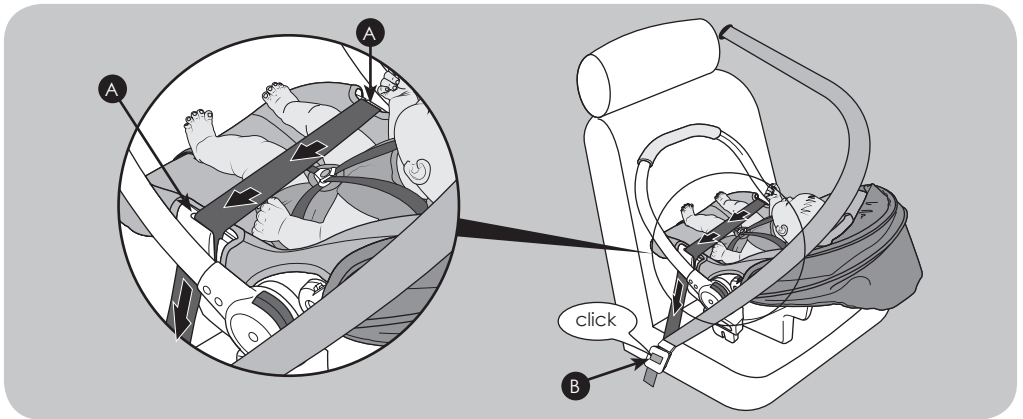
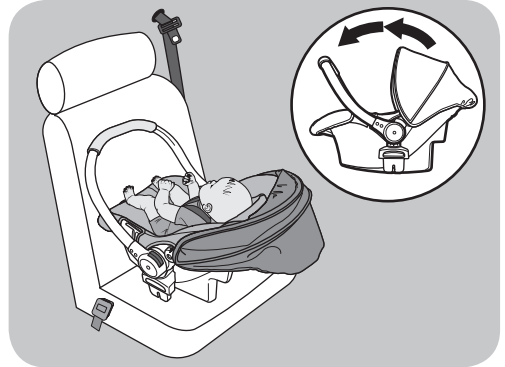

Place the vehicle lap belt across the child car seat and slide the lap belt into the slots (A) on both sides of the child car seat. Buckle up the vehicle seat belt (B).

Fitting the child seat in a vehicle (continued)

Take the diagonal belt around the back of the child car seat and slot it into the rear seat belt guide (C).

Thread the section of diagonal belt which runs from the seat buckle to the rear seat belt guide (C) between the shell and the pushchair adaptor (D).

Once the seat belts are in their correct mounting points make sure the seat belt buckle is secure and there are no twists in the belt and that all slack is removed from the lap and diagonal sections.

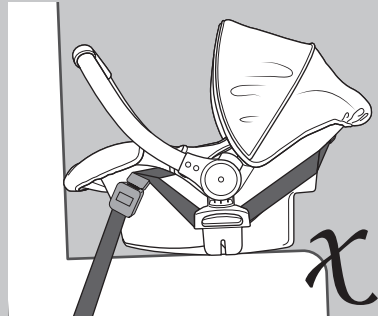
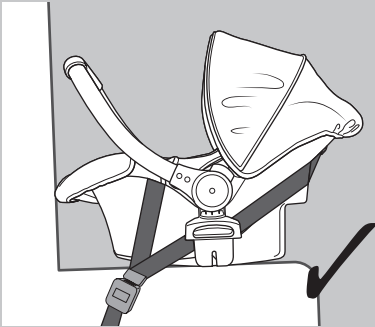
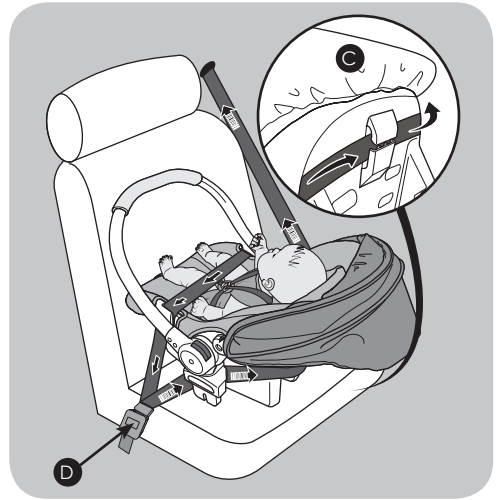

Note: If the vehicle seatbelt buckle is above the top edge of the child seat then this car seat is not suitable for the vehicle (this is called 'buckle crunch' and can cause the vehicle seatbelt to come undone in an accident).

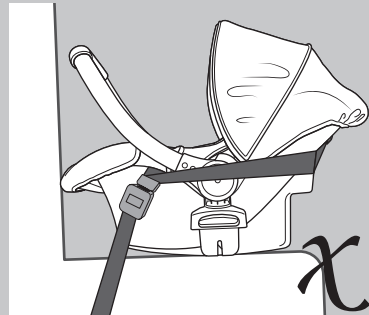

Removing and attaching the hood

To remove the hood: press the small tabs (A) on each side of the child car seat and slide the plastic stay out from the socket.

To re-attach the hood push the plastic stays into the sockets on each side of the carrier, ensuring they click into place.

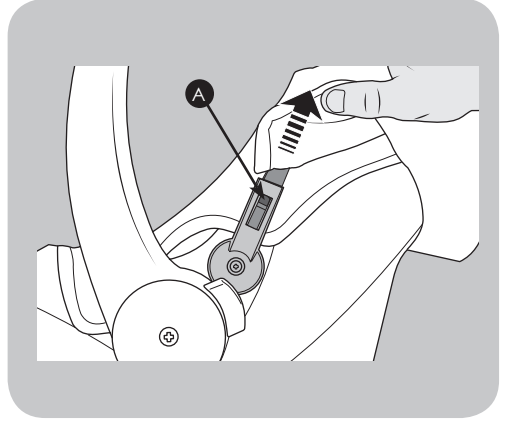

Removing the seat cover

Press the belt adjuster button and pull on the shoulder harness straps to create slack.

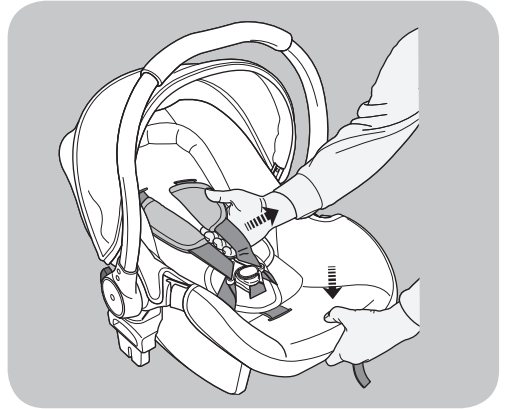

Press the red release button (A), unbuckle the harness and move the shoulder straps apart.

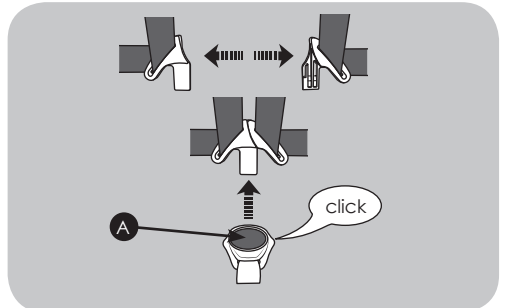

Removing the seat cover (continued)

Unhook the shoulder straps at the rear of the seat shell by sliding the straps through the slits in yoke (B). Remove the straps, pulling them out from the front of the seat.

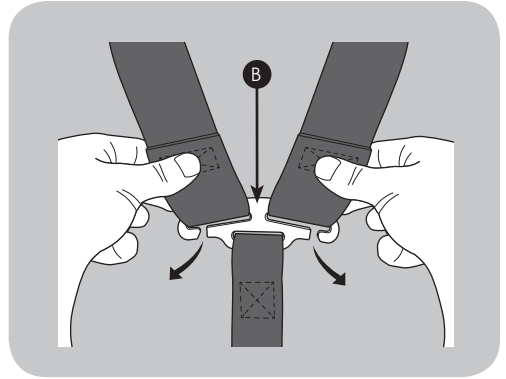

The seat cover is held in place with plastic clips at points 1, 2 & 3 on each side of the child car seat.

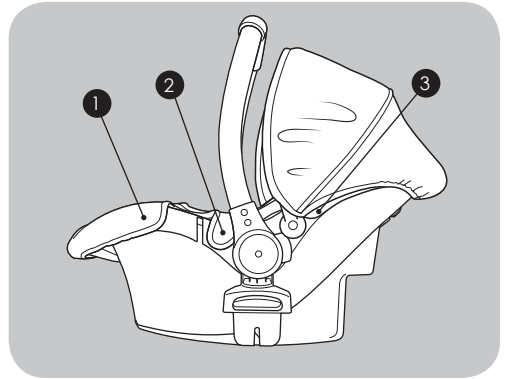

Slide the plastic clips down and out of the keyhole slots (C).

Loosen the seat cover all around the edges of the shell. Carefully pass all straps and buckles through the slots in the cover and remove the cover.

To replace: reverse the above steps.

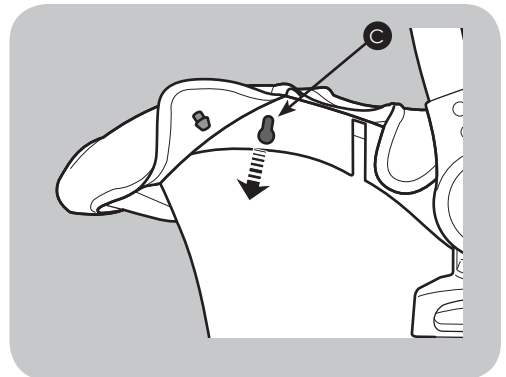

Attaching the seat to the chassis

Note: The car seat can only be fitted parent facing (as shown).

Hold the car seat so that it is facing the stroller handle. Position the car seat joints (A) above the mounting points (B) and push the seat downwards until it clicks into place.

Attention: Lift the car seat to ensure it is firmly attached to the stroller chassis.

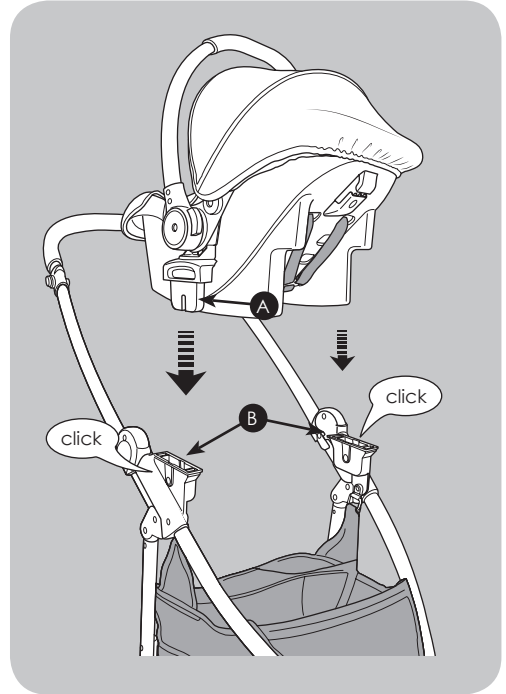

Removing the seat from the chassis

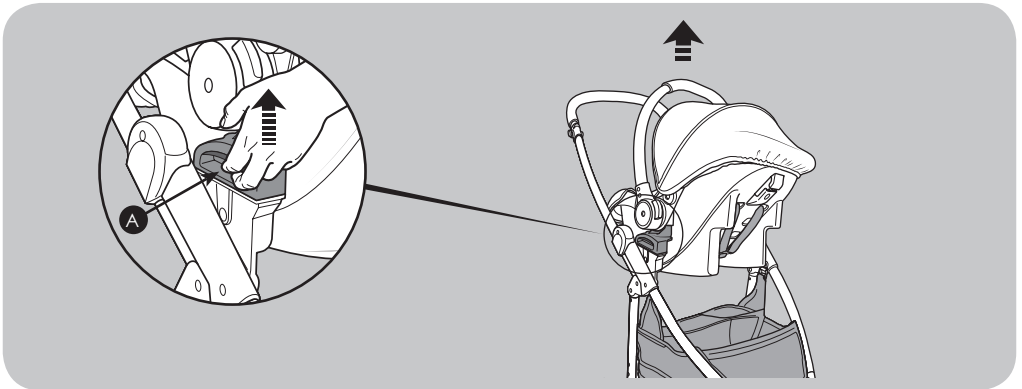

Standing in front of the chassis, lift up the release catches (A) on each side of the car seat and lift it from the chassis.

Care and maintenance

- 1) Store this child car seat in a safe place when not in use.
- 2) **DO NOT** place heavy objects on top of it.
- 3) Always store the child car seat in a dry environment.
- 4) **DO NOT** store the child car seat near a direct heat source such as a radiator.

Covers

- 1) The seat cover is easily removable and should be hand washed with a pH neutral soap and cold water.
- 2) Do not press, iron, dry clean, tumble dry or wring the covers.
- 3) Do not use solvents, caustic or abrasive cleaning materials.
- 4) Dry flat, away from direct heat and sunlight.
- 5) If the seat covers need to be replaced only use parts certified by the manufacturer. They are the only ones that are guaranteed to have been safety tested and designed to fit this seat.

Plastic/Metal Parts

- 1) Wipe clean using a mild soap and warm water.
- 2) You must not remove, dismantle or alter any part of the seat shell.
- 3) You must not oil or lubricate any part of the seat shell.

Inspection

- 1) Check your child car seat regularly for wear and tear.
- 2) The child car seat may have a slight rattle when not in use, this is normal. If in any doubt, contact the retailer immediately.
- 3) Check the adjustable parts of your child seat at intervals of about 6 months to ensure it is still fits correctly for your growing child.

Your 3 year warranty

Whilst we make and test our products to the highest standards of durability there's always a small chance of a hiccup! Our promise is to repair, replace or refund a MyChild product that has an identified manufacturing defect from the date of purchase for a full 3 years thereafter at no extra cost.

However, you must register within 28 days of the date of purchase to receive the full 3 years guarantee!

To receive your full guarantee you can register your product by: visiting www.mychild.co.uk/warranty.html and complete the warranty form, or by telephone on 0161 335 2508.



Customerservice@kooltrade.co.uk
Imported by MyChild. M34 3QA
www.mychild.co.uk
Tel: 0161 335 2508